



DUALLIE OWNER'S MANUAL

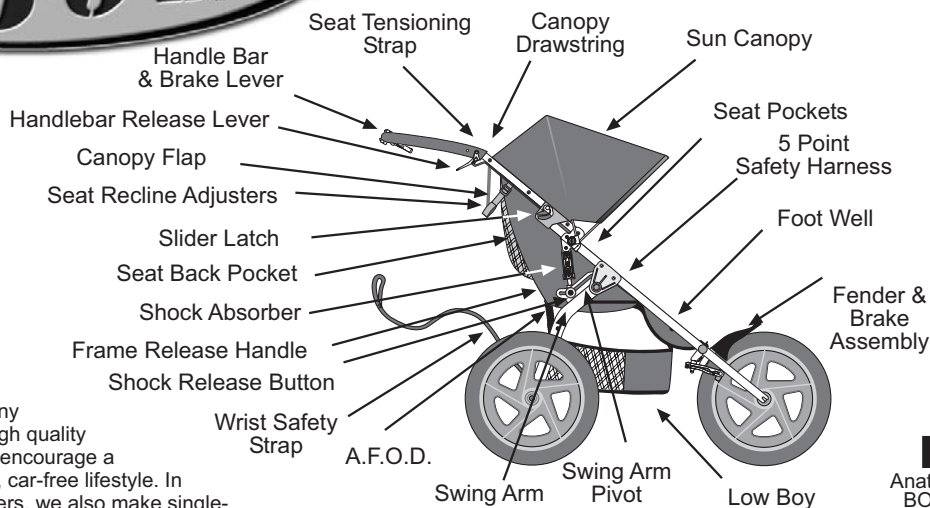

Fig. 1
Anatomy of the BOB Duallie

BOB is a company that produces high quality products, which encourage a healthy, outdoor, car-free lifestyle. In addition to strollers, we also make single-wheeled cargo trailers for bicycles. See www.bobgear.com for our complete line of products. **Before attempting to assemble or use your new stroller, read and understand these operating instructions completely to insure proper assembly and operation.** If you are unclear on any point, contact your dealer or BOB before use.

▲ WARNINGS ▲

- ▶ Never leave children unattended in the stroller.
- ▶ Failure to properly assemble or install the quick release wheels on this stroller may result in the wheels becoming detached while moving and a subsequent loss of control of the stroller.
- ▶ Always use seat harnesses to avoid serious injury to children from sliding or falling out of stroller.
- ▶ Never allow occupants to stand in stroller.
- ▶ The parking brake is not designed as a stopping brake. The brake should not be used to slow or stop the stroller. The brake is intended to park the stroller on flat surfaces, not on inclines. Never leave your children in the stroller unattended with or without the parking brake set!
- ▶ Do not strap parcels or bags to the handle as it affects the balance and stability of the stroller and can cause it to tip over backwards.
- ▶ The maximum carrying capacity of the stroller is 100 pounds.
- ▶ Do not place sharp objects in the seatback pocket as your child leans against this and can be injured as a result.
- ▶ When starting out, always make sure that your kid's hands and feet are away from wheel spokes.
- ▶ The Duallie is not equipped for use after dark. If you intend to use it at night, we recommend installing wheel reflectors and a lighting system available through your local bike shop.
- ▶ We do not recommend wearing roller skates or inline skates while pushing stroller.

BOB IS NOT RESPONSIBLE FOR INJURY, DAMAGE, OR FAILURE THAT RESULTS FROM OWNER'S FAULTY ASSEMBLY OR MAINTENANCE AFTER SHIPPING.

AGE RECOMMENDATIONS: - It is recommended that your child be a minimum of 6 to 8 weeks old before riding in the stroller. Young babies incapable of holding their head up must be provided additional head and neck support to ride safely. For jogging and off road use, children should be at least 6 to 8 months old. Children develop at different rates. Consult with your pediatrician regarding the suitability of the stroller use with your child.

ASSEMBLY INSTRUCTIONS:

Reference Fig. 1 as it describes the various parts of the Duallie.

- 1 UNPACK:** Remove stroller, stroller wheels, front fender and front quick release from packaging. Plastic packaging material was used to protect the front fork dropouts, the front wheel axles and the shock slider brackets. Remove these plastic pieces.

- 2 SWINGARM:** Rotate the swingarm away from the front of the stroller until the shocks engage in the first position (Fig. 2). The shocks' locking pins will "snap" and lock into position 1.

- 3 HANDLE:** Rotate the stroller handle up to the fully open position. Slider Latches will lock into place (Fig. 3).

- 4 REAR WHEEL:** Place the rear wheel quick release lever in the open position, as shown in Fig. 4. Insert the rear wheel's stub axle into the hole in the rear dropout. If the axle does not slide in easily, loosen the quick release adjuster nut (Fig. 4) by hand. Re-insert the axle fully into the rear dropout until the snap ring on the axle comes in contact with the dropout (Fig. 5). Move the quick release lever to the closed position (Fig. 6). The word CLOSE should be clearly visible and the quick release lever should be pointing up towards the seat. When properly adjusted, it will require considerable pressure (80-105 inch/pounds) to close the lever. If you do not feel this resistance (too loose or too tight), return the quick release lever back to the open position (Fig. 4), and adjust the adjusting nut (clockwise to tighten, counterclockwise to loosen). Move the quick release lever to the closed position (Fig. 6). NOTE: Follow all

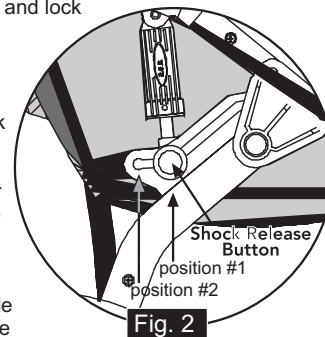

Fig. 2
Swingarm in unfolded position with shock in position #1

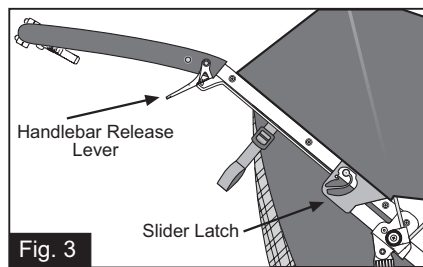

Fig. 3

Stroller with handle in the unfolded position.

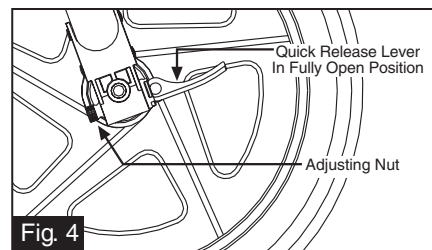

Fig. 4

Rear wheel quick release with lever in open position.

instructions exactly. If you are unsure how to operate the quick release, consult your dealer or contact BOB.

5 FENDER INSTALLATION:

Before installing the front wheel, you will need to attach the fender. The two attachment screws can be found already installed on the frame (Fig. 7). Remove the two fender mounting screws. You may wish to remove a fabric screw (right or left) to give better access to the cross tube fender screw. Align the hole in the metal tab of the fender with the threaded hole in the center of the front cross tube and install screw (Fig. 8). Align the hole in the plastic fender with the hole in the brake mounting plate and install screw (Fig. 8). Center fender on stroller and tighten both screws.

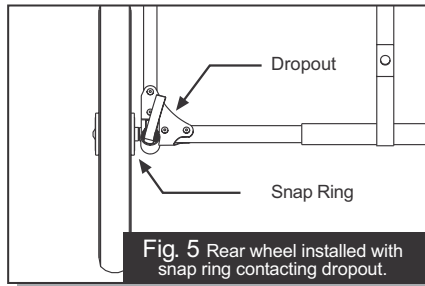

Fig. 5 Rear wheel installed with snap ring contacting dropout.

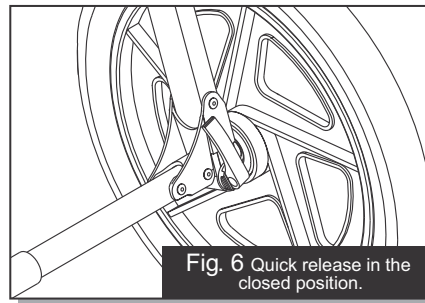

Fig. 6 Quick release in the closed position.

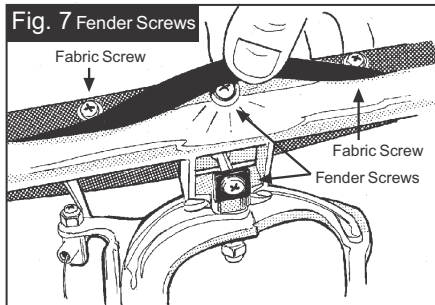

Fig. 7 Fender Screws

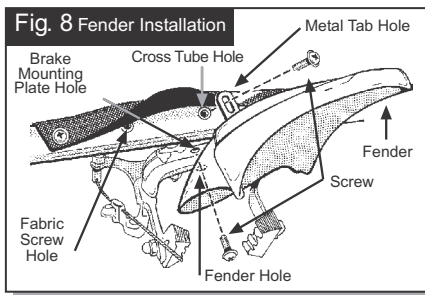

Fig. 8 Fender Installation

6 FRONT WHEEL:

(Fig. 9) shows the anatomy of the front wheel quick release. Remove the adjuster nut and one spring from the quick release, and install the quick release rod into the wheel axle. Install the spring (small end towards the center of the wheel) and screw on the adjuster nut by turning in a clockwise direction. Tighten the nut only three turns (final adjustment will be made after the wheel is installed).

As the stroller's tires are wider than the rims, and as the brake pads are adjusted to the rims, the brake caliper will need to be opened before mounting or removing the wheel. Open the brake quick release (Fig. 10) by squeezing the brake pads together with your right hand, and pulling down and then rotating the brake quick release lever outward with your left hand.

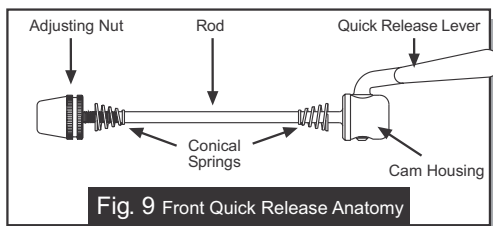

Fig. 9 Front Quick Release Anatomy

The front fork's dropouts are slotted to receive the front wheel (Fig. 11). Slide the wheel into the dropouts so that the quick release lever is on the left hand side of the stroller. Make sure the wheel is centered in the frame and that the axle is touching the back of the dropout slot.

Securely tighten the wheel in place as follows: With the quick release lever in the open position (Fig. 11), tighten the adjusting nut (clockwise) until it comes in contact with the stroller dropout. Move the quick release lever to the closed position (Fig. 12). This should require significant pressure. If you do not feel significant resistance, turn the quick release lever back to the open position (Fig. 11), and hand tighten the adjusting nut by one or two more turns in the clockwise direction. Move the quick release lever toward the closed position (Fig. 12). The word CLOSE should be clearly visible and the quick release lever should be parallel to the stroller frame tube. It should require considerable pressure (80-105 inch-pounds) to close the lever when properly adjusted. NOTE: Follow all instructions exactly. If you are unsure how to operate the quick release, consult your dealer or call BOB.

7 PARKING BRAKE: The brake is a parking brake, it prevents the stroller from moving while loading and unloading it. The parking brake is not designed as a stopping brake. We do not recommend using the brake to slow or stop the stroller. The brake is intended to park the stroller on flat surfaces not on inclines. Never leave your children in the stroller unattended with or without the parking brake set! After installing the front wheel, the brake caliper will need to be placed in the closed position. Close the brake quick release (Fig. 10) by squeezing the brake pads against the wheel with your right hand and rotating the brake quick release lever in the counter (over)

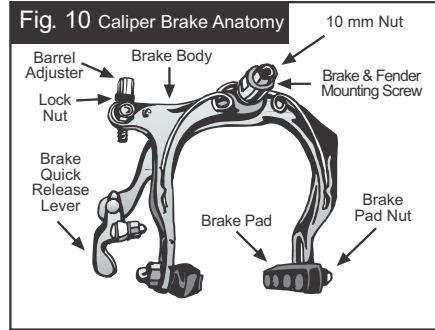

Fig. 10 Caliper Brake Anatomy

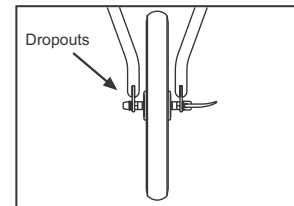

Fig. 11 Front wheel dropouts shown with wheel in correct position. Quick release lever perpendicular to the dropout.

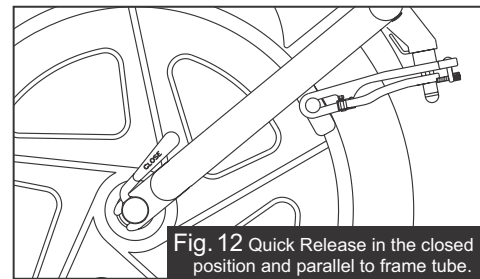

Fig. 12 Quick Release in the closed position and parallel to frame tube.

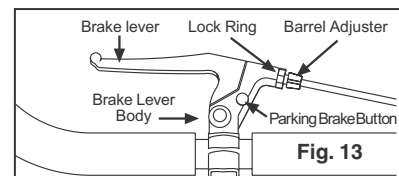

Fig. 13

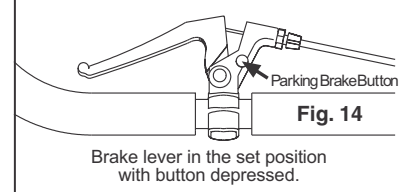

Fig. 14

Brake lever in the set position with button depressed.



DUALLIE OWNER'S MANUAL

clockwise direction. To set the parking brake, squeeze the brake lever and press and hold the button down, then release lever (Fig. 13 & 14). When the brake is properly set, the button will remain depressed and the lever will appear as shown in Fig. 14. To release the parking brake, simply squeeze the brake lever and the button will "pop" up. For the parking brake to work correctly, it is critical that the brake be adjusted properly. Squeeze the brake lever and verify that the brake pads contact the rim as shown in Fig. 16. If they are misaligned, use a 10mm wrench to loosen brake pad nuts, slide pads into correct position and tighten securely. The cable tension is pre-adjusted at the factory yet the brake cable will need periodic adjustment (as the cable stretches slightly and the black cable housing compresses over time). To adjust cable tension, there are two barrel adjusters in the brake assembly (Fig. 10 & 13). To tighten the cable, loosen the lock ring and turn the barrel adjuster in the counter clockwise direction. Secure the barrel adjuster in the new position by tightening the lock ring against the caliper or brake lever body. There should be a 3/16" clearance between the rim and brake pads as shown in Fig. 15. If gap is not equal on each brake pad, you can reposition the brake on the frame by loosening the 10 mm nut (Fig. 16) with a 10mm wrench, adjust to the gap shown in Fig. 15 and retighten the same nut. If you do not understand these instructions, or feel the brake is adjusted incorrectly, take the stroller to your dealer for proper adjustment. If your brake pads (Fig. 10) are worn, see your dealer for replacements.

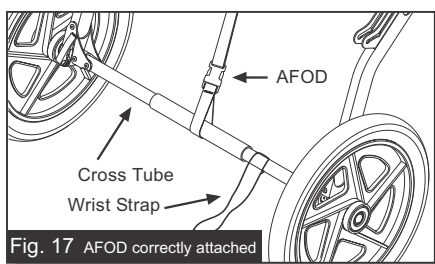
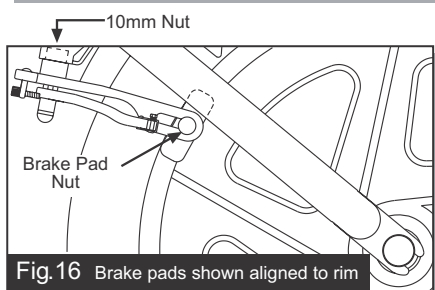
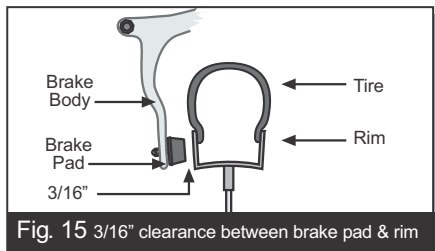

8 AFOD: With the stroller in the opened position, attach the AFOD (Anti-Fly-Out-Device) around the cross tube with the plastic buckle (Fig. 17). It is important that the AFOD is always properly secured when using the stroller, as it is part of the child's seat restraint system. It is, however, necessary to release the AFOD in order to fold the stroller.

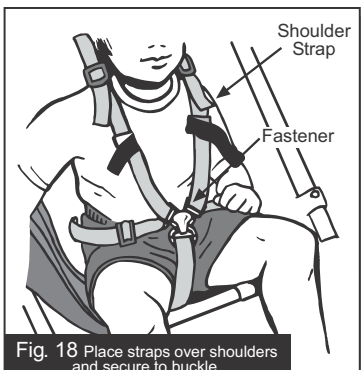

9 SUN CANOPY: The Duallie features a two position canopy. To fully open the canopy, rotate the assembly forward until the fabric is

taut. The rear safari flap should be freed from the Velcro to give additional sun protection. To reduce the size of the sun canopy, pull the canopy toward the handlebar. The additional fabric can be gathered by pulling the canopy (Fig. 1) drawstring and securing the cord lock.

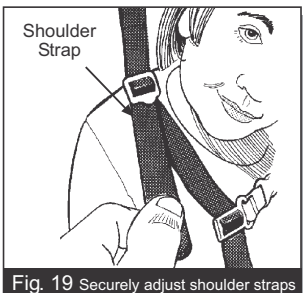

10 SEAT TENSIONING: The seat compartments are divided by a section of nylon webbing that runs the length of the stroller. From time to time it may be necessary to increase the tension of the webbing. To adjust the tension start with handlebar in the fully open position as shown in Fig. 3. At the top of the seat the webbing loops over the handlebar cross tube and connects to a ladderlock. At the bottom of the ladderlock there is a tensioning strap. Pull on this strap to increase the tension.

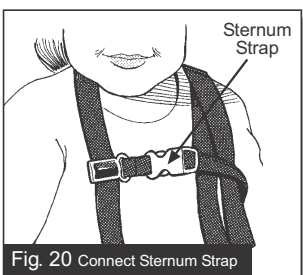

11 SEAT SAFETY HARNESS: To secure your child in the seat, put one strap (grey) over each shoulder and snap the male buckle into the female receiver on the crotch strap (Fig. 18). Adjust shoulder straps to be snug and secure (Fig. 19). Connect and adjust the sternum strap (red), see Fig. 20. **WARNING:** Never place passengers in the stroller without securing them in the harness. Unrestrained passengers can affect the control of the stroller. Total Passenger Weight Limit - 100 Pounds (45 Kilograms)

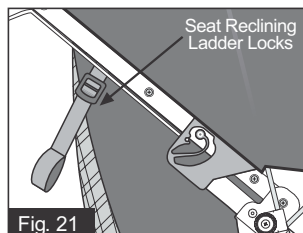

12 RECLINING SEAT: Set parking brake before making any seat adjustments. To recline the seat, rotate the ladder locks (Fig. 21) forward thus releasing the reclining straps. To raise the seat, pull the reclining straps until you obtain the desired position. The seat back can be adjusted to recline anywhere between the fully upright position and the fully reclined position (Fig. 21 & 22).

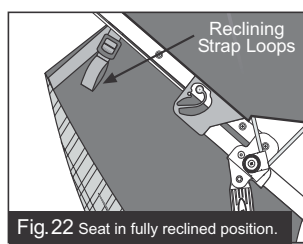

13 SHOCK ABSORBERS: The suspension system features two shock positions to provide a comfortable ride for kids of different weights. The two positions are shown in Fig. 2. Position 1 is intended for occupants up to 50 lbs. (22.5 kg), while position 2 is intended for occupants from 50 to 100 lbs. (22.5 to 45 kg) total. The Duallie features a sliding track and spring loaded shock axle that automatically locks in place when it aligns with either of the two shock settings. Shock position adjustments should be made with the stroller unloaded. The Duallie will lock into position 1 when unfolding the

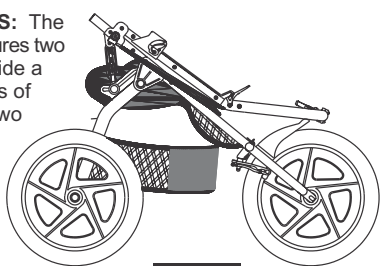

Fig. 23

Stroller with handle folded

stroller. To use the stiffer shock position, move the shock from position 1 to position 2 by depressing the shock release button (Fig. 2) with one hand, and with the other hand, lift slightly and pull the shock backward. When the shock axle is properly aligned in position 2, the axle will "snap" into place. Repeat this process for the second shock. To move the shock from position 2 to position 1, reverse the above process for both shocks.

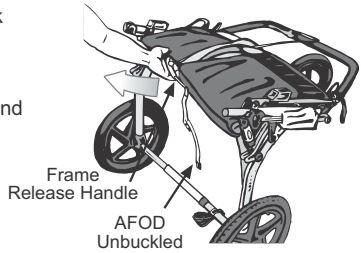

Fig. 24

Pull handle upwards sharply to fold

14 FOLDING: Remove children from stroller. Remove the contents of the Low Boy cargo pouch. Unbuckle the AFOD strap (Fig. 17). The shock absorbers must be in position 1 (Fig. 2) before folding. Press both the right and left handlebar release levers (Fig. 3), and fold the handlebar forward as shown in Fig. 23. Locate the frame release handle underneath the seat (Fig. 24) and pull upwards sharply. This will allow the lower frame to fold together, as shown in Fig. 25. The folded stroller can be made even more compact by removing the front and rear wheels. The front wheel is removed by opening the brake quick release (Fig. 10), opening the wheel quick release and removing the wheel (see section 6). Note that it is often easier to open the brake quick release before you fold the handlebar. The rear wheels are removed by opening the rear wheel quick release (Fig. 4), and removing the wheels.

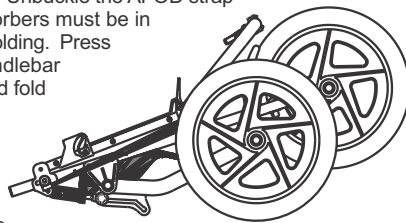

Fig. 25

Stroller in fully folded position

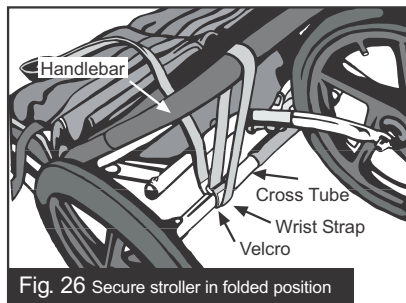

Fig. 26 Secure stroller in folded position

The Wrist Strap can be used to keep the stroller in the folded position for transport and storage. With the stroller folded, loop the end of the wrist strap around the handlebar and back to the cross tube and fix the Velcro surfaces together (Fig. 26).

15 TIRE PRESSURE: IMPORTANT: Inflation pressure must always fall within the range embossed on the sidewall of the tire (usually 25-35 p.s.i.)

STROLLER CARE and MAINTENANCE : The fabric is 100% polyester with a stain resistant treatment that makes cleanup easy. Use a sponge with a solution of mild soap and lukewarm water (maximum temperature of 100 degree Fahrenheit). Rinse thoroughly with clean water to remove soap then air dry. Do not use detergent. Regular maintenance should include: Verifying tire pressure, verifying that all screws and fasteners are tight, and wiping parts clean with a rag. To reduce the possibility of squeaks, periodically apply a small amount of lubricant (Triflow, 3-in-one, or light sewing machine oil) to the frame pivot axle and interior faces of the pivot bracket, as shown in figure 27.

STORAGE: It is best to store your stroller indoors when it is not in use. This will prolong its attractive appearance. Extended exposure to the sun's ultraviolet rays can fade and damage the fabric, tires, and plastic parts.

CARGO: The Duallie is equipped with four small pockets for the kids, a seatback pocket and a Low Boy cargo pouch under the stroller. Adding weight to the seatback changes the center of gravity of the stroller, and increases the possibility that it will tip over backwards. For this reason, loads in the seatback pocket should never exceed two pounds (1 kg.). Although the seatback is padded, it is important to remember that this is what your child leans against. Never place sharp or injurious objects into the seatback pocket.

Apply Lubricant to Interior Faces of Bracket

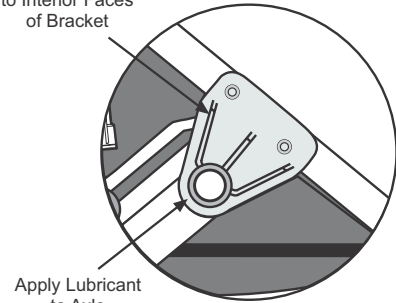

Fig. 27

Pivot Axle Lubrication

LIMITED WARRANTY

BOB Trailers Inc. takes pride in its workmanship and strives to manufacture the best products possible. Therefore, we warranty our Duallies against defects in material and workmanship subject to the conditions listed below. Since no product is indestructible, it does not cover defects attributable to or resulting from normal wear, abuse or alteration.

- ▶ Frame is warranted for 5 years.
- ▶ Components and fabric are warranted for one year.
- ▶ Warranty is only valid for the original purchaser.
- ▶ Proof of purchase is required to exercise this warranty.
- ▶ Labor and freight charges are not included.
- ▶ Normal wear, neglect, abuse, accidents, improper assembly or maintenance, or the installation of parts or accessories not compatible with the original intended use of the stroller, as sold, are not covered by this Warranty.
- ▶ Warranty claims must be made through an authorized dealer.
- ▶ This warranty is limited to the repair or replacement of the defective part. BOB shall in no event be responsible for consequential or special damages.
- ▶ This Limited Warranty is the only express or implied warranty applicable to BOB. Any implied warranties, including warranties of merchantability and fitness shall be limited in scope and duration in accordance with this limited warranty.

STROLLER ACCESSORIES

Also available for Duallie Models



WARM FUZZY
 Warm Fuzzy Seat Insert - The ultimate in plushness & comfort. Thick, polypropylene fleece will give you and your child a warm fuzzy! (Two required for Duallie)

WEATHER SHIELD
 Your little one will be dry & comfortable in bad weather, strolling with the BOB Weather Shield!..