



Sport Utility Stroller Owner's Manual

(800) 893-2447 www.bobgear.com email- info@bobgear.com
Ph: (208) 375-5171 Fax: (208) 375-5172, BOB Trailers, Inc. 5475 Gage St. Boise, ID 83706



BOB is a company that produces high quality products designed to promote a healthy outdoor life-style. See www.bobgear.com for our complete line of products. **Before attempting to assemble or use your new stroller, read and understand these operating instructions completely to ensure proper assembly and operation.**

If you are unclear on any point, contact your dealer, place of purchase or BOB [toll free 1-800-893-2447] before use.

A list of dealers is listed on our website [www.bobgear.com].

For updates to this manual, our warranty and other recent product notifications, please visit www.bobgear.com periodically.

We also suggest that you register your stroller with us by going directly to www.bobgear.com/register.

⚠ WARNINGS ⚠

- Never leave child unattended in the stroller.
- Always use seat harness to avoid serious injury from falling or sliding out.
- Never allow occupants to stand in stroller.
- Always use Wrist Safety Strap.
- Do not attach parcels or bags to the handle or frame of stroller except those recommended by BOB, as stroller can become unstable and tip over.
- Do not place sharp objects in the seatback pocket as your child leans against this and can be injured as a result.
- When starting out and during use, always make sure the child's hands and feet are away from wheels.
- Do not use stroller on stairs or steep inclines. Stroller can tip over, resulting in injury.
- Never pull a loaded stroller backward up stairs. Doing so could damage the suspension system – leading to frame failure and serious injury to the user and/or the occupants.
- Use extreme caution when using stroller on uneven and/or unpaved surfaces as these conditions create additional hazards and can lead to loss of stability and injury.
- Do not make any modifications to the stroller. Doing so voids the warranty and could lead to a dangerous condition and possible injury.
- Transportation of stroller requires protection to prevent damage to stroller components that could lead to an accident and injury.
- We do not recommend wearing roller skates or in-line skates while pushing stroller.
- The stroller is not equipped for use after dark. If you intend to use at night, we recommend installing a front and rear lighting system available through your local bike shop.
- Failure to properly assemble or install the quick release wheels on this stroller may result in the wheels becoming detached while moving and a subsequent loss of control, resulting in serious injury or death. (See sections 4 & 6)
- The parking brake is not designed as a stopping brake. The parking brake should not be used to slow or stop the stroller because doing so could cause the stroller to stop abruptly, resulting in loss of control. The parking brake is intended to park the stroller on flat surfaces, not on inclines. Never leave your children in the stroller unattended with or without the parking brake set!
- Never load or unload the stroller without the parking brake set. (See section 8)
- The maximum weight capacity of the stroller is 70 lbs (32 kg) (occupant plus luggage weight). Do not exceed the maximum capacity, as stroller will become unstable. (See section 10)
- Always jog with the stroller seat in the fully upright position. Jogging with the seat in reclined positions may result in a loss of stability and injury. (See section 11)
- When seat is fully reclined, (Fig. 23) backward tip-over is more likely, and may result in an accident or injury, as seat and/or passenger may contact ground before handlebar. (See section 11)
- Follow instructions and use care when folding and unfolding stroller to prevent finger entrapment. (See section 14)

BOB IS NOT RESPONSIBLE FOR INJURY, DAMAGE, OR FAILURE THAT RESULTS FROM OWNER'S FAULTY ASSEMBLY OR MAINTENANCE AFTER SHIPPING.

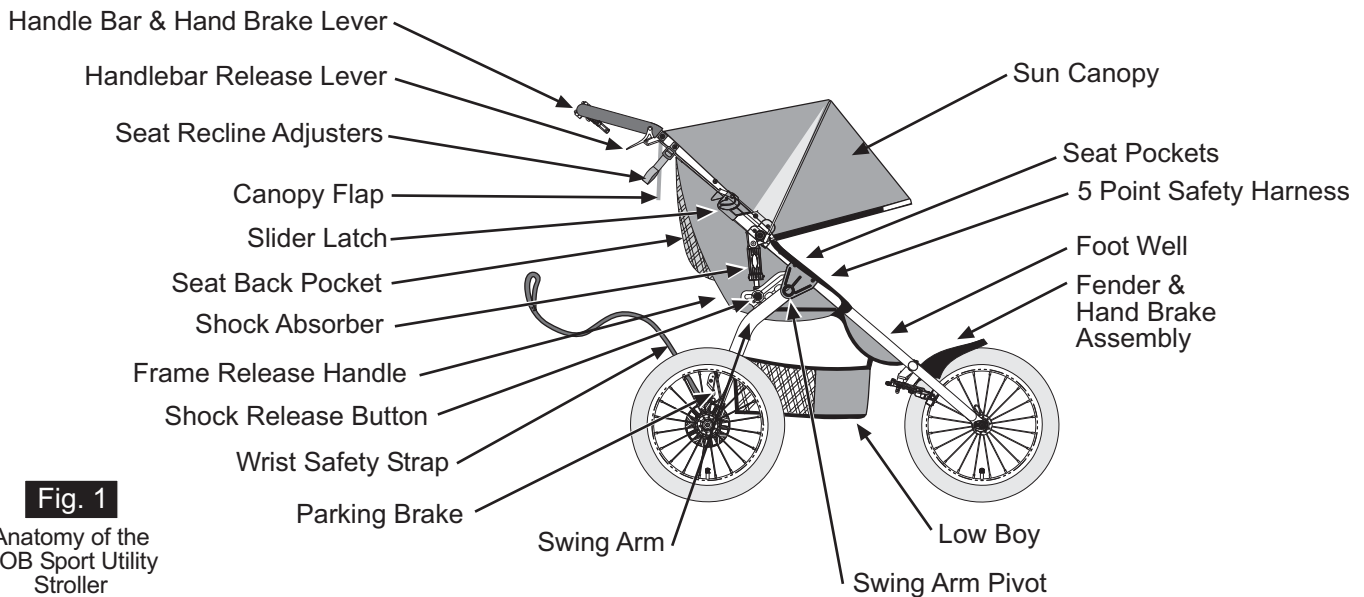

Fig. 1

Anatomy of the BOB Sport Utility Stroller

AGE RECOMMENDATIONS:

We do not recommend that children under 8 weeks old be placed in the stroller seat. For jogging and off road use, we recommend that children not be younger than 8 months old. Young babies incapable of holding their head up must be provided additional head and neck support to ride safely. Children develop at different rates. Consult with your pediatrician regarding the suitability of stroller use with your child.

ASSEMBLY INSTRUCTIONS:

Reference Fig. 1 as it describes various parts of the stroller.

WHAT YOUR STROLLER BOX SHOULD CONTAIN:

- Stroller
- Wheels (2 rear, 1 front)
- Fender (inside poly bag)
- Front Wheel Quick Release (inside poly bag)
- This Owner's Manual

1. UNPACK:

Remove stroller, stroller wheels, front fender and front quick release from packaging. Plastic packaging material was used to protect the front fork dropouts, the front wheel axles, handlebar release levers and the metal shock brackets. Remove and discard packaging material to avoid choking and suffocation hazards.

2. SWING ARM:

Rotate the swing arm away from the front of the stroller until the shocks engage in the first position (Fig. 2). Each shock locking pin will “snap” and lock into position 1.

3. HANDLEBAR:

Rotate the stroller handlebar up to the fully open position. Make sure Slider Latches lock into place as shown in Fig 3.

4. REAR WHEEL:

Prior to installing the rear wheels, position the brake bar in the Unlocked position as shown in Fig. 17. Place the rear wheel quick release cam lever in the open position, as shown in Fig. 4. Insert the rear wheel's stub axle into the hole in the rear dropout. If the axle does not slide in easily, loosen the quick release tension adjusting nut (Fig. 4) by hand. Re-insert the axle fully into the rear dropout until the axle shoulder or snap ring on the axle comes in contact with the dropout (Fig. 5). Move the quick release cam lever to the closed position (Fig. 6). The word CLOSE should be clearly visible and the quick release cam lever should almost touch the dropout. When properly adjusted, it will require considerable force (37-50lbs or 165-222N) to close the lever. If you do not feel this resistance (too loose or too tight), return the quick release cam lever back to the open position (Fig. 4), and adjust the tension adjusting nut (clockwise to tighten, counterclockwise to loosen). Move the quick release cam lever to the closed position (Fig. 6).

⚠ WARNING: Failure to properly adjust quick release may result in wheel loss and serious personal injury. If you are unsure how to operate the quick release, consult your dealer or call BOB.

5. FENDER INSTALLATION:

Before installing the front wheel, you will need to attach the fender. The two attachment screws can be found already installed on the frame (Fig. 7). Remove the two fender mounting screws. You may wish to remove a fabric screw (right or left) to give better access to the cross tube fender screw.

Align the hole in the metal tab of the fender with the threaded hole in the center of the front cross tube and install screw (Fig. 8). Align the hole in the plastic fender with the hole in the brake mounting plate and install screw (Fig. 8). Center fender on stroller and tighten both screws.

6. FRONT WHEEL:

It's important to your safety, performance and enjoyment to understand how the front wheel quick release works on your stroller. We urge you to ask your dealer how to do the things described in this section before you attempt them yourself, and that you have your dealer check your work before you use the stroller. If you have even the slightest doubt as to whether you understand something in this section of the Manual, talk to your dealer.

Wheel Quick Release

⚠ WARNING: Strolling with an improperly adjusted wheel quick release can allow the wheel to wobble or fall off the stroller, which can cause serious injury or death. Therefore, it is essential that you:

- Ask your dealer to help you make sure you know how to install and remove your wheels safely.
- Understand and apply the correct technique for clamping your wheel in place with

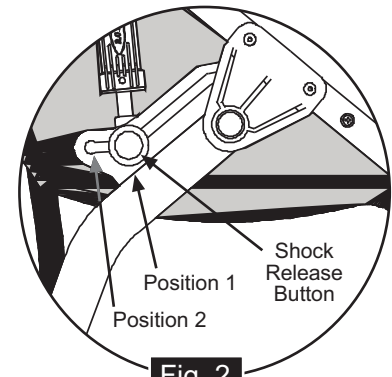

Fig. 2

Swingarm in unfolded position with shock in position 1

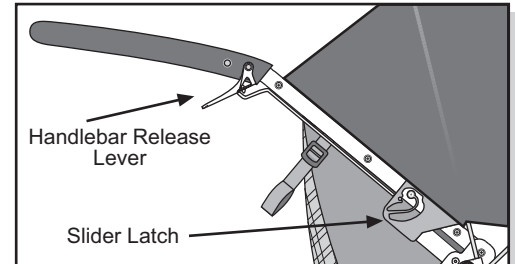

Fig. 3 Handlebar in the fully open position

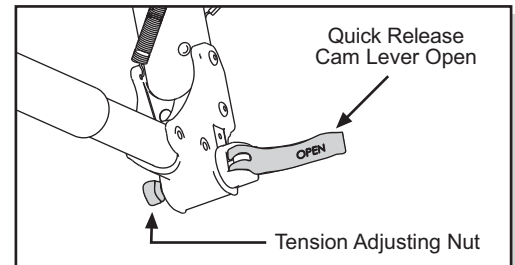

Fig. 4 Rear wheel Quick Release with Cam Lever in open position

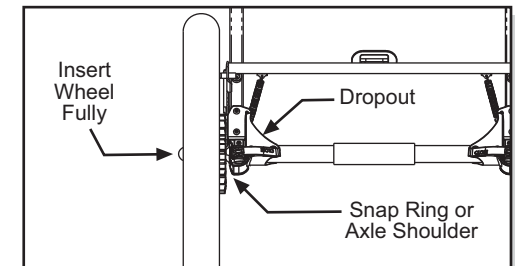

Fig. 5 Rear wheel properly installed

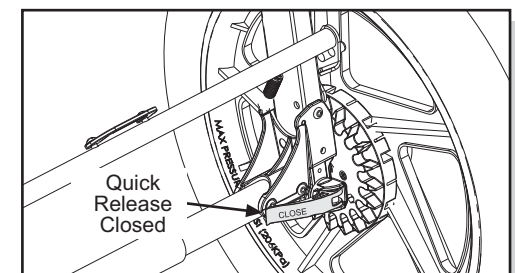

Fig. 6 Quick Release Cam Lever in the closed position (right side shown)

a quick release.

- Each time, before you use the stroller, check that the wheel is securely clamped.

The wheel quick release uses a cam action to clamp the stroller wheel in place (Fig. 9). Because of its adjustable nature, it is critical that you understand how it works, how to use it properly, and how much force you need to apply to secure the wheel.

⚠ WARNING: The full force of the cam action is needed to clamp the wheel securely. Holding the nut with one hand and turning the lever like a wing nut with the other hand until everything is as tight as you can get it will not clamp the wheel safely in the dropouts.

Adjusting the quick release mechanism

The wheel hub is clamped in place by the force of the quick release cam pushing against one dropout and pulling the tension adjusting nut, by way of the skewer, against the other dropout. The amount of clamping force is controlled by the tension adjusting nut. Turning the tension adjusting nut clockwise while keeping the cam lever from rotating increases clamping force; turning it counterclockwise while keeping the cam lever from rotating reduces clamping force. Less than half a turn of the tension adjusting nut can make the difference between safe clamping force and unsafe clamping force.

Front Wheel Secondary Retention Devices

All 2007 and newer BOB Strollers have front forks which utilize secondary wheel retention devices designed to help keep the wheel from disengaging if the quick release is incorrectly adjusted. Secondary retention devices are not a substitute for correct quick release adjustment. The secondary retention devices on your stroller are the integral type that is formed into the outer faces of the front fork dropouts.

⚠ WARNING: Do not remove or disable secondary retention devices. As its name implies, they serve as a back-up for a critical adjustment. If the quick release is not adjusted correctly, the secondary retention devices can reduce the risk of the wheel disengaging from the fork. Removing or disabling the secondary retention devices may also void the warranty. Secondary retention devices are not a substitute for correct quick release adjustment. Failure to properly adjust the quick release mechanism can cause the wheel to wobble or disengage, which could cause you to lose control and fall, resulting in serious injury or death.

Installing a Quick Release Front Wheel:

- Move the quick release cam lever so that it curves away from the wheel (Fig. 9). This is the FULLY OPEN position.
- Insert the wheel between the fork blades so that the axle seats firmly at the top of the slots that are at the tips of the fork blades — the fork dropouts. The quick release cam lever should be on the left side of the stroller (Fig. 11 & 12).
- Holding the quick release cam lever in the OPEN position with your right hand as shown in Fig. 11, tighten the tension adjusting nut with your left hand until it is finger tight against the fork dropout.
- While pushing the wheel firmly to the top of the slots in the fork dropouts, and at the same time centering the wheel rim in the fork, move the quick release cam lever upwards and swing it into the FULLY CLOSED position (Fig. 9 & 12). The lever should now be parallel to the fork blade and curved toward the wheel. To apply enough clamping force, you should have to wrap your fingers around the fork blade for leverage, and the quick release cam lever should leave a clear imprint in the palm of your hand.

⚠ WARNING: Securely clamping the wheel takes considerable force. If you can fully close the quick release without wrapping your fingers around the fork blade for leverage, and the quick release cam lever does not leave a clear imprint in the palm of your hand, the tension is insufficient. Open the lever; turn the tension adjusting nut clockwise a quarter turn; then try again.

- If the quick release cam lever cannot be pushed all the way to the fully closed position parallel to the fork blade, return the lever to the OPEN position. Then turn the tension adjusting nut counterclockwise one-quarter turn and try tightening the lever again.

Removing a Quick Release Front Wheel:

- To remove the front wheel, open the brake quick release (Fig. 10).
- Move the wheel's quick-release lever from the locked or FULLY CLOSED position to the FULLY OPEN position (Fig. 9). Your front fork has integral secondary retention devices. Loosen the tension adjusting nut enough to allow removing the wheel.
- Raise the front wheel a few inches off the ground and tap the top of the wheel with the palm of your hand to knock the wheel out of the front fork.

7. HAND BRAKE:

The hand brake may be used to help slow or stop the stroller.

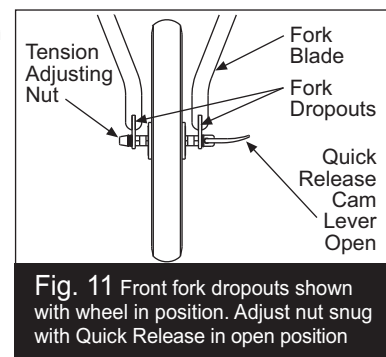
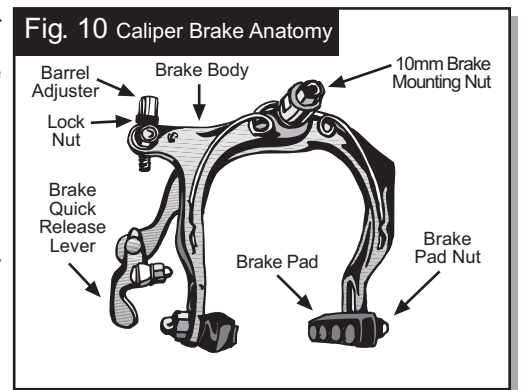
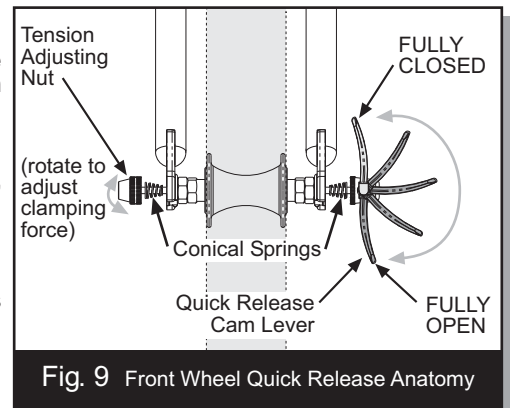
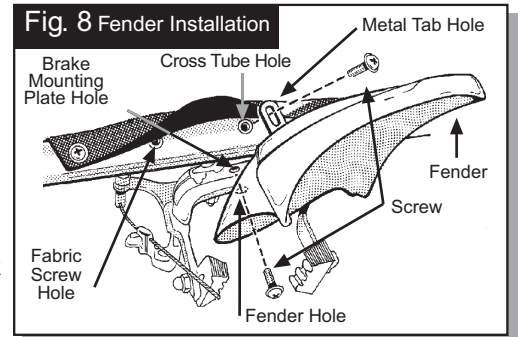
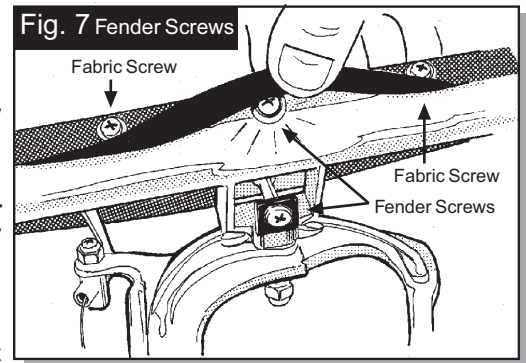

The hand brake is not a parking brake. (See section 8)

After installing the front wheel, the brake caliper will need to be placed in the closed position. Close the brake quick release lever (Fig. 10) by squeezing the brake pads against the wheel with one hand, then rotate the brake quick release lever in the counter clockwise direction with your other hand until it points downward. For the hand brake to work correctly, it is critical that it be adjusted properly. Squeeze the brake lever and verify that the brake pads contact the rim as shown in Fig. 15. If they are misaligned, use a 10mm wrench to loosen brake pad nuts, slide pads into correct position and tighten securely. The cable tension is pre-adjusted at the factory yet the brake cable will need periodic adjustment (as the cable stretches slightly and the black cable housing compresses over time). To adjust cable tension, there are two barrel adjusters in the brake assembly (Fig. 10 & 13). To tighten the cable, loosen the lock ring and turn the barrel adjuster in the counter clockwise direction. Secure the barrel adjuster in the new position by tightening the lock ring against the caliper or brake lever body. There should be a 3/16" (5mm) clearance between the rim and brake pads as shown in Fig. 14. If gap is not equal on each brake pad, the brake caliper can easily be repositioned on the frame by loosening the caliper mounting nut (Fig. 15) with a 10mm wrench, adjust to the gap shown in Fig. 14 and re-tighten the same nut. If you do not understand these instructions, or feel the brake is adjusted incorrectly, take the stroller to your dealer for proper adjustment. If your brake pads (Fig. 10) are worn, see your dealer for replacements.

8. PARKING BRAKE:

The parking brake prevents the stroller from moving while loading and unloading. The parking brake is not designed as a stopping brake.

⚠ WARNING: Do not use the parking brake to slow or stop the stroller because doing so could cause the stroller to stop abruptly, resulting in loss of control.

⚠ WARNING: The parking brake is intended to park the stroller on flat surfaces, not on inclines. Never leave your child in the stroller unattended with or without the parking brake set!

To set the parking brake, press the brake bar down into the locked position (Fig. 16) with your foot on the red foot pedal – making sure the locking pin fully engages the locking disk. To ensure the brake is set properly, attempt to roll the stroller fore and aft after setting the brake. If the stroller will not roll, the brake is set properly. To release the parking brake, lift up on the red foot pedal with your foot until the brake bar springs up into the fully unlocked position (Fig. 17).

9. SUN CANOPY:

The stroller features a two position canopy. To fully open the canopy, rotate the assembly forward until the fabric is taut. The rear canopy flap should be freed from the Velcro to give additional sun protection. To reduce the size of the sun canopy, pull the canopy toward the handlebar.

10. SECURE CHILD IN SEAT:

WARNING: The maximum weight capacity of the stroller is 70 lbs (32kg) (occupant plus luggage weight). Maximum occupant height is 44 inches or (112 cm). Do not exceed the maximum weight or height, as stroller will become unstable.

⚠ WARNING: Avoid serious injury from falling or sliding out. Always use seat harness.

⚠ WARNING: Never leave your child in the stroller unattended with or without the parking brake set.

NOTE: Rear wheels should not rotate when parking brake is set.

- Set parking Brake. Rotate parking brake bar down into locked position.
- Place child in seat. Slip one shoulder strap over each shoulder. Position crotch strap between legs (Fig. 18).
- Fasten shoulder straps. Insert both shoulder strap buckles into crotch strap buckle (Fig. 19).

NOTE: Crotch strap should be adjusted to have a snug fit.

- Adjust shoulder strap height. Adjust height of shoulder strap to fit just above child shoulder height (Fig. 20).
- Adjust shoulder strap. Open Velcro pads. Slide buckle up or down to adjust straps. Seat harness should fit snug and be comfortable (Fig. 20).
- Tighten lap straps. Adjust lap straps to fit snug and be comfortable (Fig. 21).

NOTE: For heavier and or taller passengers (closer to the maximum limits above), auxiliary harness anchors may be utilized by unfolding anchor Velcro (Fig. 19), sliding buckles above anchors, and reconnecting Velcro to keep buckles in place.

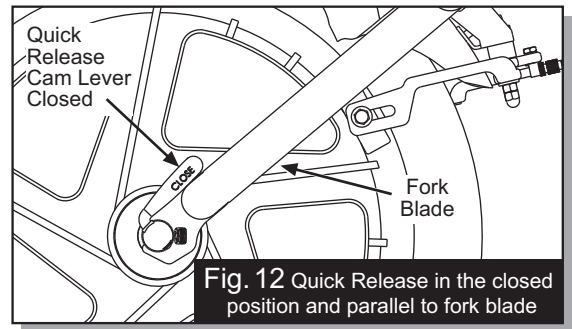

Fig. 12 Quick Release in the closed position and parallel to fork blade

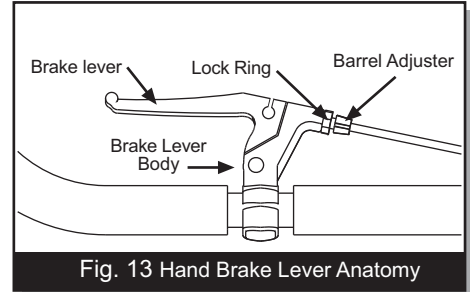

Fig. 13 Hand Brake Lever Anatomy

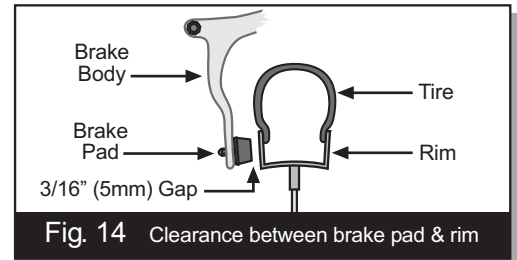

Fig. 14 Clearance between brake pad & rim

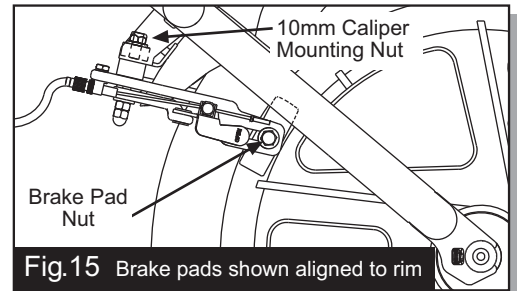

Fig. 15 Brake pads shown aligned to rim

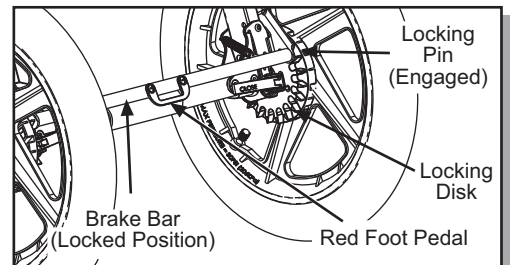

Fig. 16 Parking Brake - Locked position

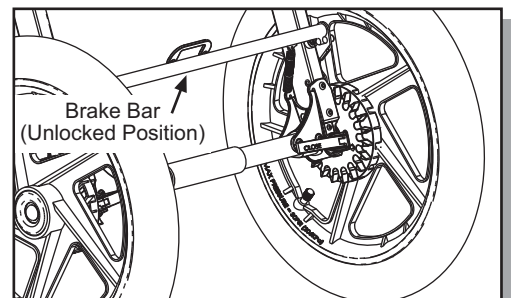

Fig. 17 Parking Brake - Unlocked position

11. RECLINING SEAT:

⚠️ **WARNING: Set parking brake before making any seat adjustments.**

To partially recline the seat, rotate the ladder lock buckles forward thus releasing the reclining straps. (Fig 22)

To fully recline the seat, unfasten side release buckles at seat back. (Fig. 23)

⚠️ **WARNING: When seat is fully reclined, (Fig. 23) backward tip-over is more likely, and may result in an accident or injury, as seat and/or passenger may contact ground before handlebar.**

Conditions that make backward tip-over more likely to occur:

- Heavier and or taller passengers (closer to our maximum limits in this manual) make backward tip-over more likely.
- Adding weight to the seat back pocket (max weight 2 lbs. / 1 kg.).
- Elevating the front wheel. Be careful when going up curbs, steps or other obstacles.
- Pushing down on handlebar.
- Jogging and or running. Always jog or run with the seat in the fully upright position.
- Hanging items from handlebar. Items should not be hung from handlebar when seat is in fully reclined position.
- Using the stroller on uneven terrain and inclines.
- To help prevent backward tip over, always hold handlebar.

To raise the seat to the fully upright position, fasten side release buckles and pull the reclining strap loops. (Fig. 22 & 23).

For additional head clearance in fully upright and partially reclined positions:

Fold panel at top of seat down against seat back and attach Velcro.

Next, pull back on strap at top center of seat. Holding tension on strap, fold down and connect Velcro on seat back. This strap tension will keep the top of seat (padded panel) perpendicular to the seat back. (Fig. 22)

⚠️ **WARNING: Always jog with the stroller seat in the fully upright position. Jogging with the seat fully reclined may result in a loss of stability and injury.**

12. SHOCK ABSORBERS:

The suspension system features two shock positions to provide a comfortable ride for kids of different weights. The two positions are shown in Fig. 2. Position 1 is intended for occupant up to 40 lbs. (18 kg; total weight of occupant and cargo), while position 2 is intended for occupant from 40 to 70 lbs. (18 to 32 kg) total. The stroller features a metal shock bracket with a sliding track and spring loaded shock pin that automatically locks in place when it aligns with either of the two shock positions. Shock position adjustments should be made with the stroller unloaded. The shocks will lock into position 1 when unfolding the stroller. To use the stiffer shock position, move the shock from position 1 to position 2 by depressing the shock release button (Fig. 2) with one hand. With the other hand, lift slightly and pull the shock backward. When the shock pin is properly aligned in position 2, the pin will “snap” into place. Repeat this process for the second shock. To move the shock from position 2 to position 1, reverse the above process for both shocks.

13. WRIST SAFETY STRAP:

The wrist safety strap is designed to help prevent the stroller from rolling away should you lose your grip on the stroller. When using the stroller make sure the strap is securely looped over your wrist.

⚠️ **WARNING: Always use Wrist Safety Strap. Failure to use the Wrist Safety Strap can result in loss of control, injury and death.**

14. FOLDING:

Remove child from stroller. Remove the contents of the Low Boy cargo pouch, seat back and seat pockets. Press both the right and left handlebar release levers (Fig. 3), and fold the handlebar forward as shown in Fig. 24. Locate the frame release handle (red foam) underneath the seat (Fig. 25) and pull upwards sharply. This will allow the lower frame to fold together, as shown in Fig. 26. The folded stroller can be made even more compact by removing the front and rear wheels. To remove the front wheel, open the brake quick release (Fig. 10), open front wheel quick release, then pull the wheel forward (see section 6). Note that it is often easier to open the brake quick release before you fold the handlebar. The rear wheels are removed by releasing the parking brake (see section 8), and then opening the rear wheel quick release (Fig. 4), and pulling each wheel directly to the side.

The Wrist Safety Strap can be used to keep the stroller in the folded position for transport and storage. With the stroller folded, loop the end of the wrist safety strap around the handlebar and back to the cross tube and fix the Velcro surfaces together (Fig. 27).

15. TIRE PRESSURE:

⚠️ **WARNING: Check tire pressure before every use.**

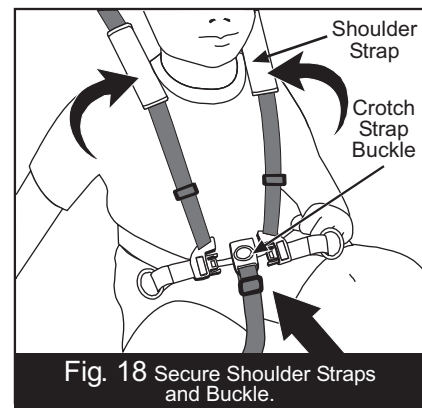

Fig. 18 Secure Shoulder Straps and Buckle.

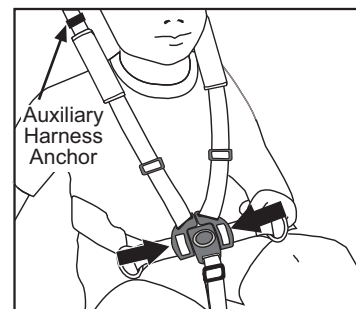

Fig. 19 Fasten Crotch Strap/ Buckle.

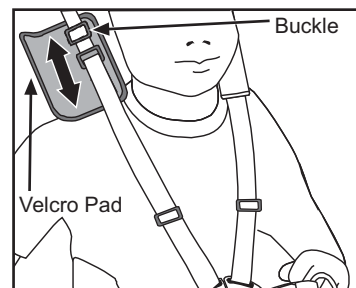

Fig. 20 Adjust Shoulder Straps.

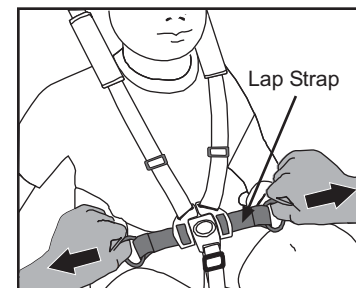

Fig. 21 Tighten Lap Straps.

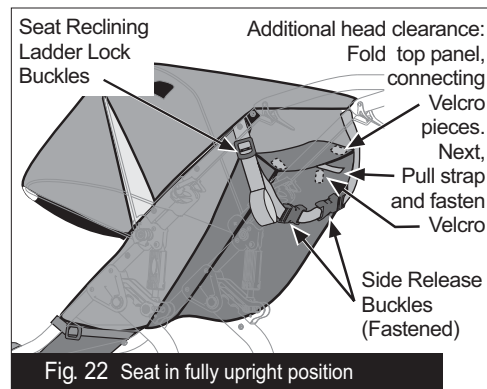

Fig. 22 Seat in fully upright position

Keep all tires inflated to 30 p.s.i.

16. STROLLER CARE & MAINTENANCE:

The fabric is 100% polyester with a stain resistant treatment that makes cleanup easy. Use a sponge with a solution of mild soap and lukewarm water (maximum temperature of 100 deg. F / 38 deg. C). Rinse thoroughly with clean water to remove soap then air dry. Do not use detergent.

Regular maintenance should include: Verifying tire pressure, verifying that all screws and fasteners are tight, checking for any tears or excessive wear in the fabric seating which could lead to an accident, and wiping parts clean with a rag. To reduce the possibility of squeaks, periodically apply a small amount of lubricant (Triflow, 3-in-one, or light sewing machine oil) to the pivot axles and interior faces of the pivot brackets, as shown in Fig. 28.

STORAGE:

It is best to store your stroller indoors when it is not in use. This will prolong its attractive appearance. Extended exposure to the sun's ultraviolet rays can fade and damage the fabric, tires, and plastic parts.

CARGO:

The stroller is equipped with two small seat pockets for your child, a seatback pocket and a Low Boy cargo pouch under the stroller. Adding weight to the seatback changes the center of gravity of the stroller, and increases the possibility that it will tip over backwards. For this reason, loads in the seatback pocket should never exceed two pounds (1 kg). Although the seatback is padded, it is important to remember that this is what your child leans against. Never place sharp or injurious objects into the seatback pocket. Maximum weight capacity for Low Boy is 10 lbs (4.5 kg).

LIMITED WARRANTY

BOB Trailers Inc. takes pride in its workmanship and strives to manufacture the best products possible. Therefore, we warranty our strollers against defects in material and workmanship for the periods and parts set forth below, subject to the conditions listed below. Since no product is indestructible, it does not cover defects attributable to or resulting from normal wear, abuse or alteration.

- Frame is warranted for 5 years.
- Components and fabric are warranted for one year.
- Warranty is only valid for the original purchaser.
- Proof of purchase is required to exercise this warranty.
- Labor and freight charges are not included.
- Normal wear, neglect, abuse, accidents, improper assembly or maintenance, or the installation of parts or accessories not compatible with the original intended use of the stroller, as sold, are not covered by this Warranty.
- Warranty claims must be made through an authorized dealer.
- This warranty is limited to the repair or replacement of the defective part. BOB shall in no event be responsible for consequential or special damages.
- This Limited Warranty is the only express or implied warranty applicable to BOB. Any implied warranties, including warranties of merchantability and fitness shall be limited in scope and duration in accordance with this limited warranty.

STROLLER ACCESSORIES

BOB offers a complete line of accessories for your stroller. Visit our website for full details, specs and images: www.bobgear.com

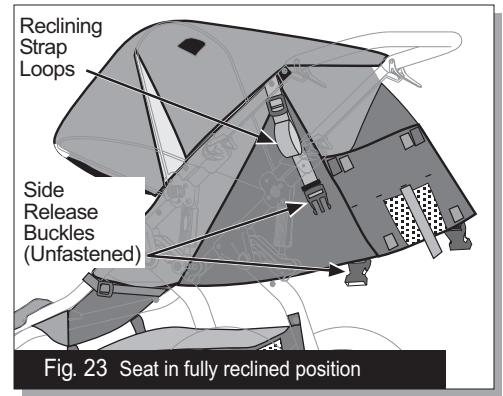

Fig. 23 Seat in fully reclined position

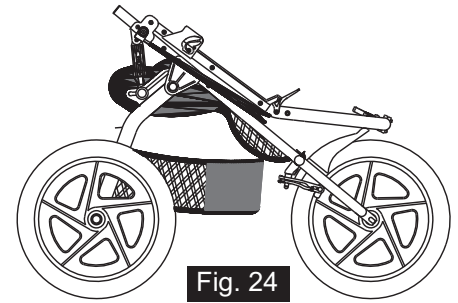

Fig. 24

Stroller with handle folded

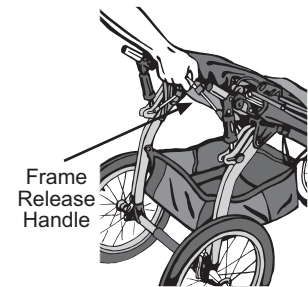

Fig. 25

Pull handle upwards sharply to fold

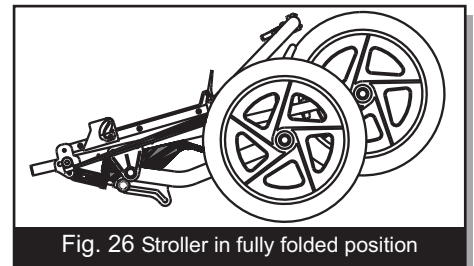

Fig. 26 Stroller in fully folded position

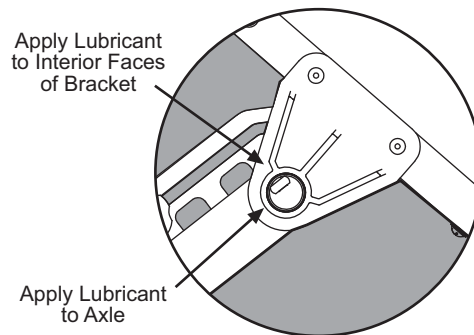

Fig. 28

Lubrication Points

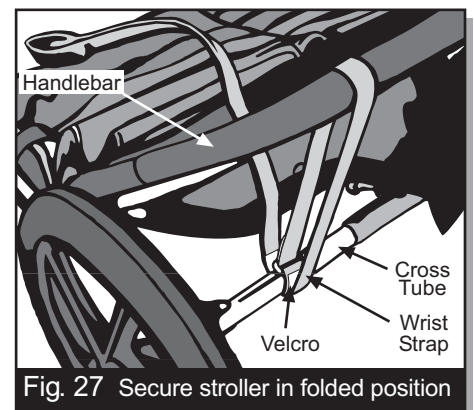

Fig. 27 Secure stroller in folded position



TRACKING INSTRUCTIONS

(800) 893-2447 www.bobgear.com email- info@bobgear.com
Phone: (208) 375-5171 Fax: (208) 375-5172, BOB Trailers, Inc. 5475 Gage St. Boise, Idaho 83706

We have added an enhanced feature to our jogging strollers that allows the customer to fine tune the tracking of their stroller. This document is designed to supplement to the Owner's Manual. **Proceed with initial setup and use of your stroller and only refer to this document if you believe there is a tracking problem with your stroller.**

All fixed three wheeled vehicles can be easily influenced to deviate from a straight path. In some cases strollers can have or develop a tendency to pull to the right/left due to many different factors including tire pressure, wheel installation, road conditions and manufacturing tolerances. If you find your BOB stroller to significantly track or pull to the left or right during use on flat terrain, follow the sequence of instructions below.

Tracking Adjustment Instructions:

The fine-tuning of desired tracking should be performed in the following sequence.

- 1) Confirm the rear wheels are installed correctly. Refer to step 4 of the Owner's Manual for installation instructions.
- 2) Confirm the front wheel is installed correctly. Refer to step 6 of the Owner's Manual for correct installation instructions. When tightening the quick release make sure the front wheel is pushed straight and equally toward the back of the dropouts.
- 3) Check the tire pressure, making sure the tire pressure is exactly the same on all three tires.
- 4) Roll test the stroller as described below. It is recommended you have someone assist with this task in order to catch and return the stroller.

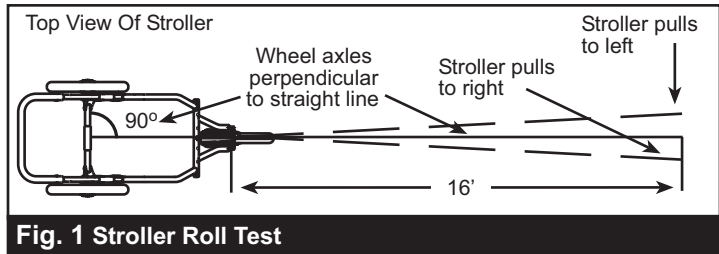

- Fig. 1 illustrates the roll test process.
- a. Empty the stroller. **Do not roll test with a child or any occupant in the stroller.**
 - b. Find a location on level ground approximately 16 ft. long. It is helpful to use an existing straight-line as a frame of reference such as the edge of the sidewalk or a painted line in a playground.
 - c. Align the stroller so the rear wheels are perpendicular to the straight line. Push and release the stroller trying carefully not to influence its direction to the left or right so it rolls straight down the test path. This step should be performed more than once to make sure the stroller was not biased left or right by the pushing action.
 - d. If the stroller consistently pulls to the left or right when pushed straight, proceed with the steps below until tracking is satisfactory. Fig 1. illustrates how to interpret the results.

Reference convention: Left and right are described as viewed from the operator's frame of reference (behind the stroller). Example: The parking brake lever is on the left side of the handlebar.

- 5) Rotate the front axle. Often tracking can be corrected by simply rotating the front wheel axle.
 - a. Open the front wheel quick release, step 6 of the Owner's Manual. Rotate axle 90 degrees in dropout, Fig. 2 and retighten quick release.
 - b. Perform roll testing again. If the stroller still consistently pulls to the left or right when pushed straight, proceed to next step.

6) Reorient the front wheel. Many times the tracking can be corrected by removing the front wheel and flipping it around and reinstalling it.

- a. Open the front wheel and front brake quick releases, step 6 of the Owner's Manual. Remove the front wheel and flip it around so the quick

release lever is on the opposite side, Fig. 3. Reinstall the front wheel, secure the wheel and brake quick release levers.

- b. Perform roll test again. If the stroller still consistently pulls to the left or right when pushed straight, proceed to next step.

7) Fine tune tracking of stroller is accomplished by using the adjustment knobs shown in Fig. 4.

If your stroller pulls to the right, proceed as follows:

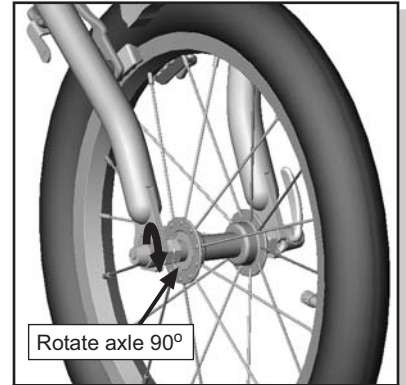

Fig. 2 Rotate Axle

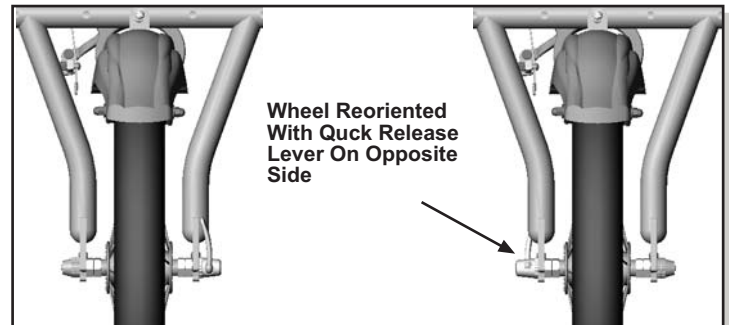

Fig. 3 Reorient Front Wheel

- a. Open quick release lever on front wheel, step 6 in the Owners Manual. It is not necessary to remove the front wheel.

- b. Turn the right knob clockwise 1-full turn, as shown in Fig. 5, thereby pushing the right side of the wheel forward. Retighten quick release.

- c. Repeat Roll test. If stroller still pulls to the right, repeat steps A and B.

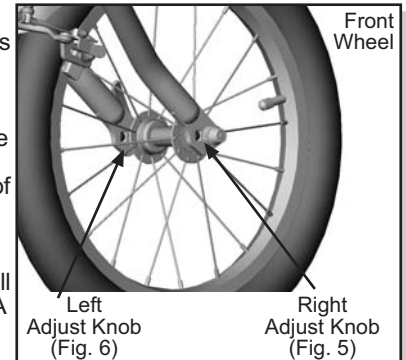

Fig. 4. Adjust Knobs

If your stroller pulls to the left, proceed as follows:

- a. Open quick release lever on front wheel, step 6 in the Owners Manual. It is not necessary to remove the front wheel.

- b. Turn the left knob clockwise 1-full turn, as shown in Fig. 6, thereby pushing the left side of the wheel forward. Retighten quick release.

- c. Repeat Roll test. If stroller still pulls to the left, repeat steps A and B.

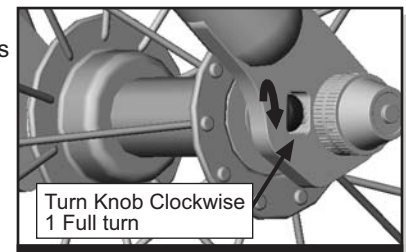

Fig. 5 Right Adjust Knob

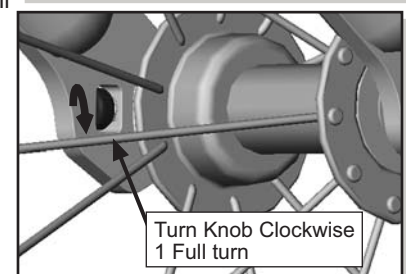

Fig. 6 Left Adjust Knob